

PSG Governor

Improved Cast Iron Case or Aluminum Case

Applications

The PSG governor is a speed-droop governor for controlling speed of small diesel, gas, and gasoline engines or small steam and industrial gas turbines, isochronously or with droop.

The governor is used to control engines or turbines driving alternators, dc generators, pumps, or compressors.

Pressure compensation provides the PSG governor with the necessary stability to control isochronously. Optimum adjustment is attained by the proper opening of the needle valve. The temperature-compensated speeder spring minimizes speed drift caused by temperature change.

The governor has its own oil pump powered by the drive shaft, and requires oil from an external source (usually engine lube oil). An oil supply from a separate sump can be used.

Rotation of the drive shaft can be in either direction. The PSG governor can be fitted with check valves to allow drive rotation in both directions.

The manual speed-setting shaft can be on either or both sides of the case. The terminal shaft can be from either or both sides of the case.

Description

The PSG governor provides hydraulic powered travel in the increase-fuel direction only. A return spring is used to provide travel in the decrease-fuel direction. The standard PSG cover provides for a vertical return spring in the governor. Governor models are available with horizontal return springs, or the governor can be fitted with a customer supplied external return spring.

Spring-driven and oil-damped ballheads are available to filter out torsional vibrations. A special temperature-compensated needle valve can be supplied to compensate for temperature effect on stability.

Droop

Droop may be set in some governors with a permanent movement of an adjustment inside the cover. Other governors are equipped with externally adjustable droop. External adjustment is available on either side of the case. Droop is adjustable from 0 to about 7 percent in all governors.

Speed Setting

Electric speed-adjusting motors or pneumatic speed-setting is available for certain remote speed-setting applications. In most cases the speed-setting shaft does not extend from the case when other types of remote speed setting are used.

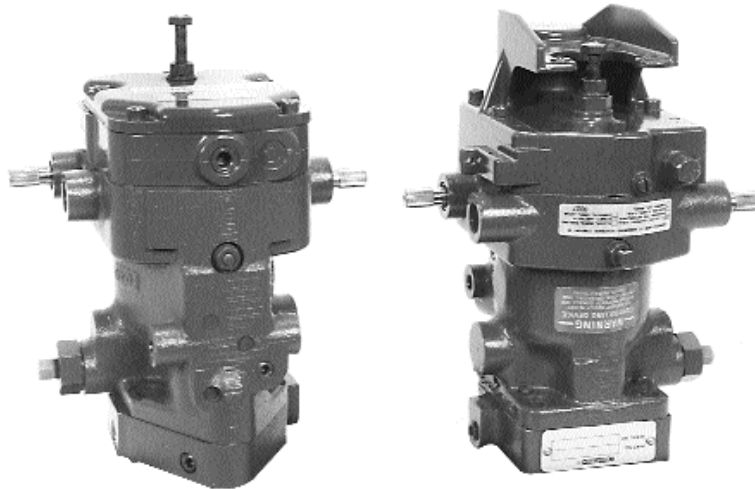

- Isochronous or droop control
- Pressure compensated
- Lever, motor, or pneumatic speed setting
- Temperature compensated
- Torsional vibration filter
- Rotary or linear output
- Cast iron or aluminum case

Specifications

SPEED SETTING

Manual	Either or both sides of the case: plain or serrated shaft; less than 45 degrees shaft rotation for full speed
Motor	12 or 24 Vdc Pittman Motor. Converter boxes are available to change supply voltage to the proper voltage for a Pittman motor
Pneumatic	Direct or reverse: 21 to 103 kPa (3 to 15 psi) most common signal; other signal ranges of 41 to 207 kPa (6 to 30 psi), 62 to 103 kPa (9 to 15 psi), 21 to 138 kPa (3 to 20 psi), 34 to 414 kPa (5 to 60 psi). Hydraulically damped against hunting due to air compressibility

GOVERNOR DRIVE

Shaft	Splined
Speed Range	1200 to 4000 rpm
Recommended Operation	1400 to 3600 rpm
Power Requirement	249 W (1/3 hp) to turn drive shaft at normal operating speed and temperature
Rotation	Clockwise, counterclockwise, or both

PILOT VALVE

Plunger Movement	Balanced between ballhead centrifugal force and speeder-spring force
Bushing	Rotated as part of governor drive shaft
Porting	Gain selection of 1, 2, or 4 round or 3 slotted

CONSTRUCTION

Case and base are cast iron, cover is aluminum or cast iron. Governors with aluminum cases are available.

MOUNTING

Install vertical or horizontal with power servo down.

CONTROL CHARACTERISTICS

Steady State Speed Band	$\pm 1/4$ of 1% of rated speed
Typical Optimum Response	6.5% off speed with 0.8 s recovery time with full load change on a 50% per second accelerated engine
Recommended Variable Speed Control Range	1200 to 4000 rpm
Pressure Compensation	Buffer spring 0.5 to 1.8 N·m (4.5 to 16 lb-in) with 1.1 N·m (9.6 lb-in) standard. Effective needle-valve opening up to 3 turns from closed
Droop	From 0% to 7% over full output travel; internal or external adjustments. External adjustment includes lock screw and max and min stop screws
Spring and Oil Damped Ballheads	Undamped natural frequency selections of 100, 180, 200, 290, 400, and 550 cycles per minute

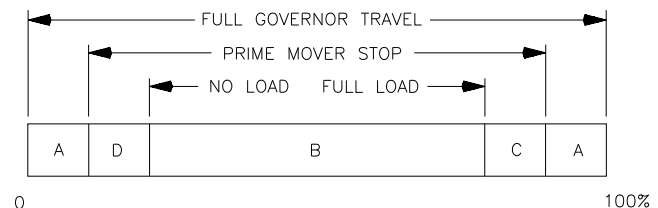
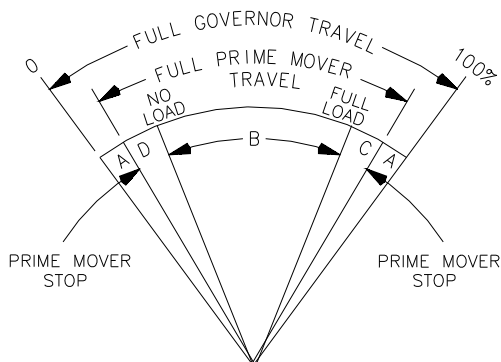

- A – OVERTRAVEL TO INSURE PRIME MOVER STOPS ARE REACHED.
- B – NO LOAD TO FULL LOAD TRAVEL – NORMALLY 2/3 OF FULL GOVERNOR TRAVEL IS RECOMMENDED.
- C – TRAVEL REQUIRED TO ACCELERATE THE PRIME MOVER.
- D – TRAVEL REQUIRED TO DECELERATE OR SHUT DOWN PRIME MOVER.

MAXIMUM WORK CAPACITY OVER FULL GOVERNOR TRAVEL OF 42' IS * . SEE ABOVE FOR RECOMMENDED GOVERNOR OUTPUT TRAVEL. IN SPECIAL APPLICATIONS MIN AND MAX PRIME MOVER STOPS MAY BE OUTSIDE THE GOVERNOR STOPS.

PSG GOVERNOR WITH PM MOTOR AND EXTERNAL RIGHT HAND DROOP

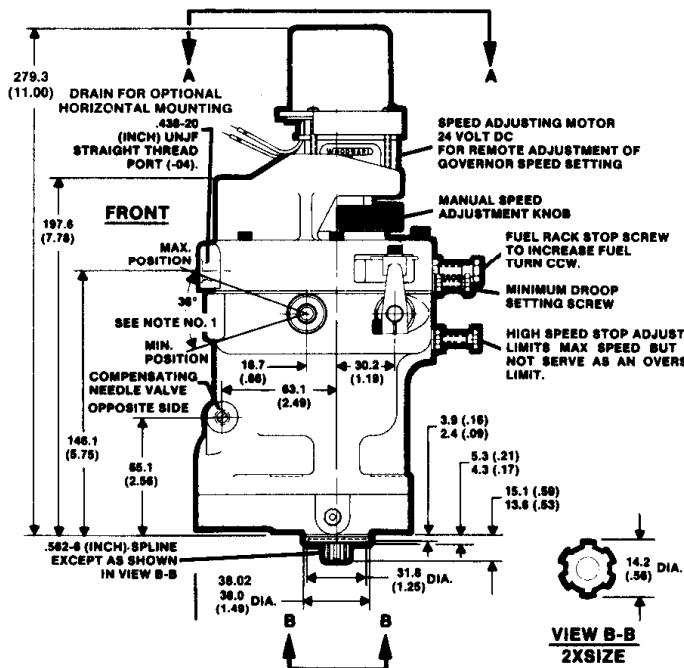

PSG GOVERNOR OPTIONS

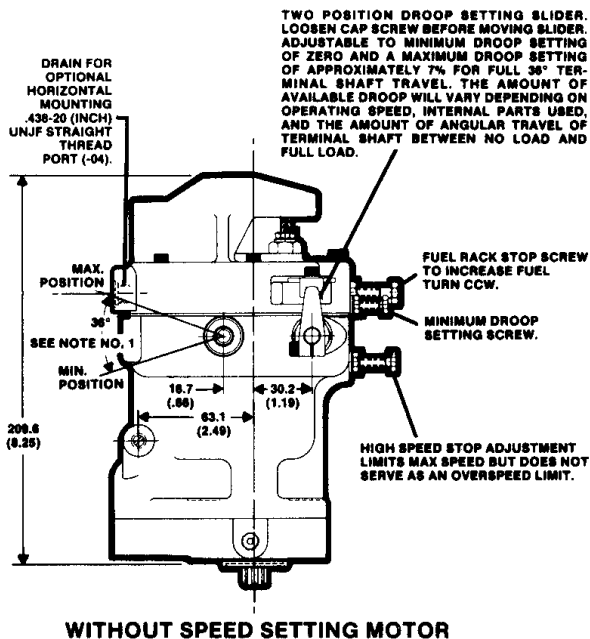

TWO POSITION DROOP SETTING SLIDER. LOOSEN CAP SCREW BEFORE MOVING SLIDER. ADJUSTABLE TO MINIMUM DROOP SETTING OF APPROXIMATELY 7% FOR FULL 36° TERMINAL SHAFT TRAVEL. THE AMOUNT OF AVAILABLE DROOP WILL VARY DEPENDING ON OPERATING SPEED, INTERNAL PARTS USED, AND THE AMOUNT OF ANGULAR TRAVEL OF TERMINAL SHAFT BETWEEN NO LOAD AND FULL LOAD.

NOTE:
1. 36° MAXIMUM USABLE STROKE AVAILABLE.

RECOMMENDED TRAVEL BETWEEN NO LOAD AND FULL LOAD IS 24°.

NOTE: POSITION NO. 1 OF OIL RESERVOIR AND PLUG USED FOR GOVERNOR MOUNTED VERTICALLY ON ENGINE.

POSITION NO. 2 (SHOWN IN DOTTED LINE) USED FOR GOVERNOR MOUNTED HORIZONTALLY ON ENGINE.

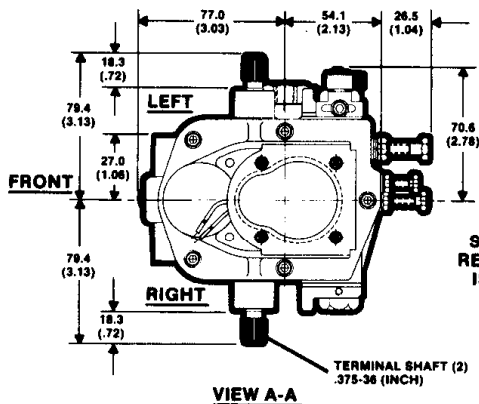

OIL MUST HAVE FREE DISCHARGE FROM THESE THREE POINTS.

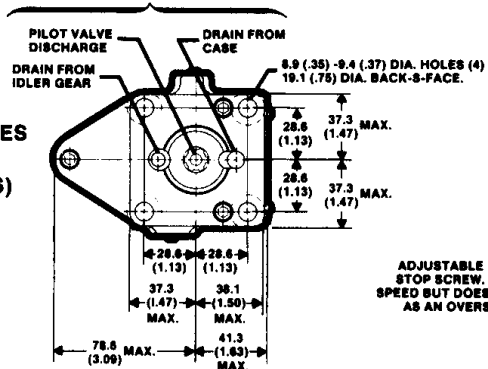

METRIC (INCHES SHOWN IN PARENTHESES)

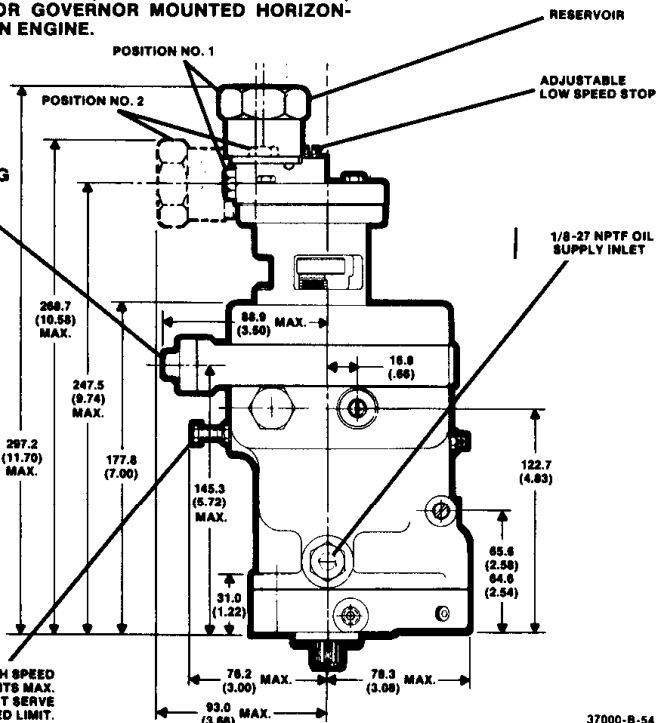

ADJUSTABLE HIGH SPEED STOP SCREW. LIMITS MAX. SPEED BUT DOES NOT SERVE AS AN OVERSPEED LIMIT.

37000-B-54

OUTLINE DRAWINGS OF CAST IRON CASE PSG GOVERNORS (DO NOT USE FOR CONSTRUCTION) METRIC (INCHES SHOWN IN PARENTHESES)

Outline Drawing
(Do not use for construction)

HYDRAULIC SYSTEM

Oil Supply Pressure	From engine lubricating system or separate sump with foot valve Minimum of 172 kPa (25 psi), max of 517 kPa (75 psi) from engine lubricating system. Maximum of 305 mm (12 inches) of suction lift from separate sump. Torque and work capacity values vary according to supply pressure
Relief Valve	Factory set for nominal 517, 1207, or 1896 kPa (75, 175, or 275 psi). Operating pressures are the relief valve pressures plus supply pressure to the pump
Flow at Normal Viscosity	Peak demand of 7.6 L/min (2 USgal/min) during transients. 1.3 L/min (0.35 USgal/min) during steady state
Filter Viscosity	40 µm (nominal) for 7.6 L/min (2 USgal/min) Must be between 50 and 3000 SUS. Normal performance is based on 100 to 300 SUS

OPERATING TEMPERATURE

Oil viscosity at operating temperature must stay within a 50 to 3000 SUS (Saybolt Universal Seconds) range. Ideal oil viscosity at operating temperature is between 100 and 300 SUS. Ambient temperature range is 29 to 93 °C (-20 to 200 °F). Consult Woodward if operating beyond these limits. Hydraulic fluid pour point must be below the lowest expected starting temperature.

OUTPUT

Terminal Shaft Linkage	Plain or serrated Engine torque output and terminal-shaft travel should be approximately linear
Return Spring	2.8, 5.6, or 8.5 N·m (25, 50, or 75 lb-in) torque at operating pressure of 690, 1379, or 2068 kPa (100, 200, or 300 psi) respectively

WEIGHT/MASS

Basic Manual Speed Setting Type	Cast iron weighs about 6.1 kg (13.5 lb). Aluminum case weighs about 4.3 kg (9.5 lb) Add about 0.7 kg (1.5 lb) for pneumatic or motor speed setting
--	---

REFERENCES

Manual 37017	<i>PSG Governor with Cast Iron Case</i>
Manual 37013	<i>PSG Governor with Aluminum Case</i>
Manual 03505	<i>Speed Adjusting Synchronizing Motor</i>
Application Note 50516	<i>Governor Linkage for Butterfly Throttle Valves</i>



PO Box 1519, Fort Collins CO, USA 80522-1519
1000 East Drake Road, Fort Collins CO 80525
Tel.: +1 (970) 482-5811 ♦ Fax: +1 (970) 498-3058
www.woodward.com

Distributors & Service

Woodward has an international network of distributors and service facilities. For your nearest representative, call the Fort Collins plant or see the Worldwide Directory on our website.

This document is distributed for informational purposes only. It is not to be construed as creating or becoming part of any Woodward contractual or warranty obligation unless expressly stated in a written sales contract.

Copyright © Woodward 1992–2000, All Rights Reserved

For more information contact: