



Motor-Services Hugo Stamp, Inc.
 Authorized Distributor and Service Center

Turn-Key Solutions - Service, Repairs, Overhauls & On-site Machining

Turbocharger



Filtration Systems



Governor & Actuator

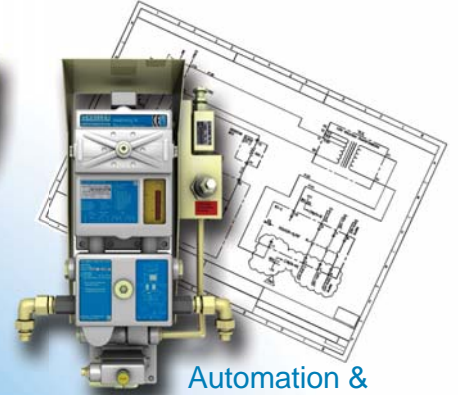

Automation & Safety Systems

Separation

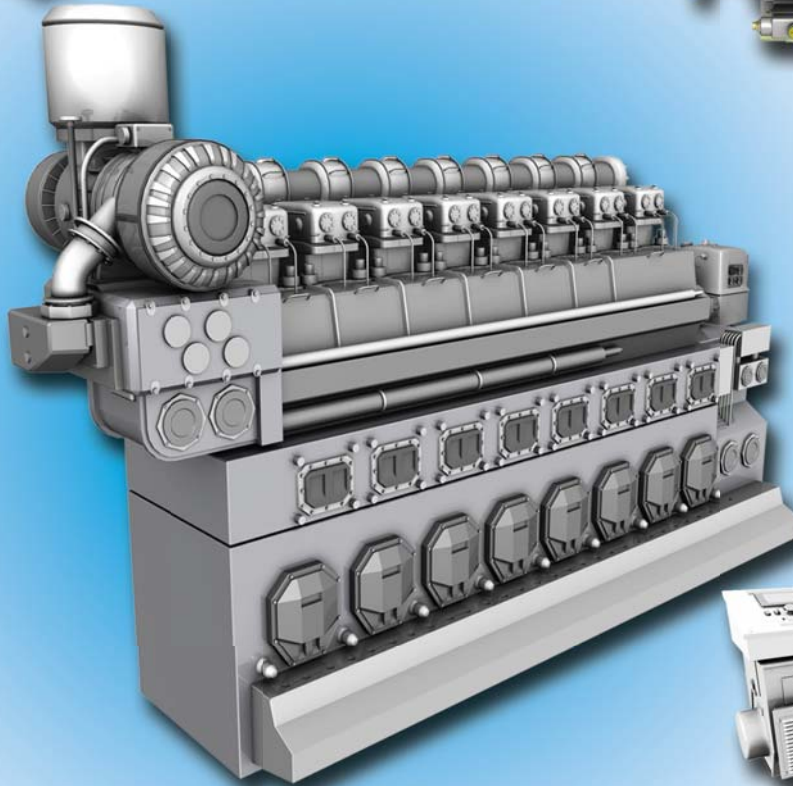

Switchboards & Instrumentation

Compressors



Generation Systems

Diagnostics



Video Inspection



Expansion Joints



Power Management Controls



AVR's & Excitation Systems

Deck Machinery & Steering Systems



Parker Yacht

GLOBAL TURNKEY PRODUCT AND SERVICE SOLUTIONS

Marine Diesel Engines













Turbochargers



Supported By Factory-trained Engineers

- MAN (Two & Four Stroke)
- Sulzer (Two & Four Stroke)
- MaK Engines
- EMD Engines
- Schaller Automation
- MAN Turbochargers
- ABB Turbochargers
- PBS Turbochargers
- Bergen Diesel Engines
- MTU Engines

	Filtration Systems
	On-site Machining
	Marine Gears
	Water Quality Monitoring
	Cylinder Head Components
	Expansion Joint Technology
	GEA Heat Exchangers Westfalia Separators/Purifiers
	Diesel Engine Indicator
	Deck Machinery/Compressors
	Water Jets

MSHS Carries Over \$13.5 Million In Inventory



CONTACT

DEPARTMENT

E-MAIL

PHONE

Torsten Elsholz	Field Service / Workshop - Southeast / Gulf Coast	service@mshs.com	954-648-7198
Justin Roeser	Service - West Coast	service@mshs.com	206-900-2616
Nico de Graaf	On-Site Machining	onsite@mshs.com	954-470-2137
Mladen Malovic	Turbocharger	turbo@mshs.com	954-612-0529
Frank Friesecke	Parts	parts@mshs.com	954-326-9491
Falk Boehme	Yacht & High-Speed/Automation & Electrical	service@mshs.com	954-684-2374